

Developing DC-DC Converter Control with Simulink

Vasco Lenzi
Senior Application Engineer

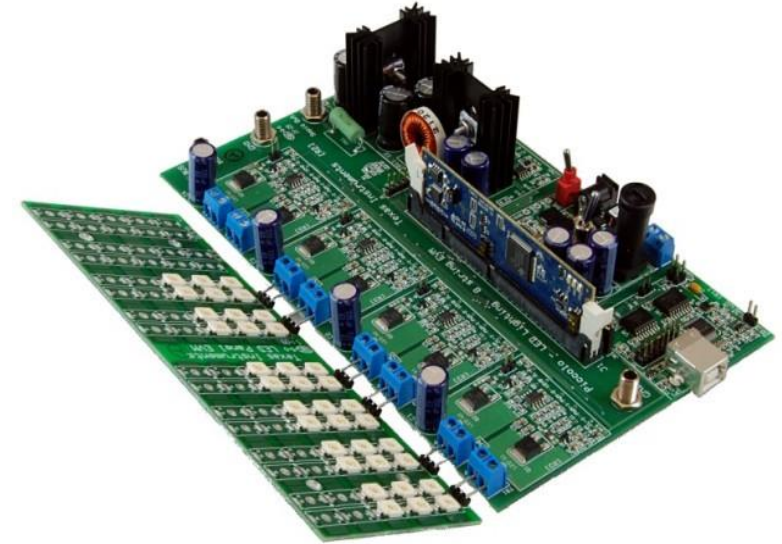

Key Takeaways

- Graphical programming across our solutions is **intuitive** and **powerful**
- State-of-the-art technologies facilitate the **design** and **verification** of complex systems developed by **multidisciplinary teams**
- Find design errors **early** and cut down development **cost** while increasing delivered **quality**.

Our Project Today

DC/DC LED Developer's Kit

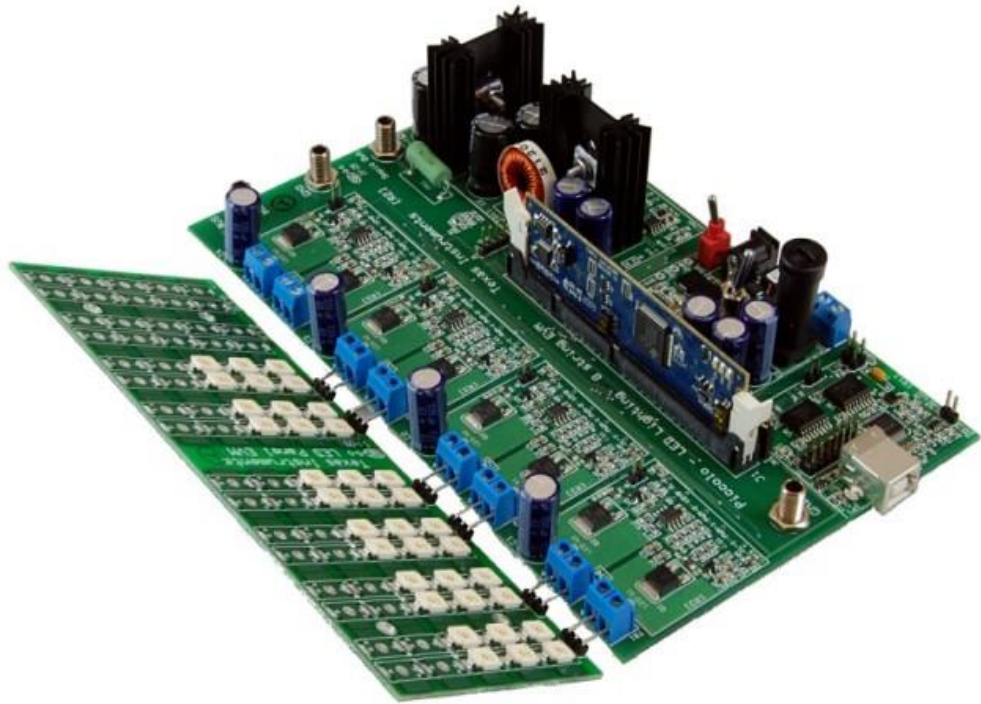

Fig 1: TMSDCDCLEDKIT



LED Head Lamp

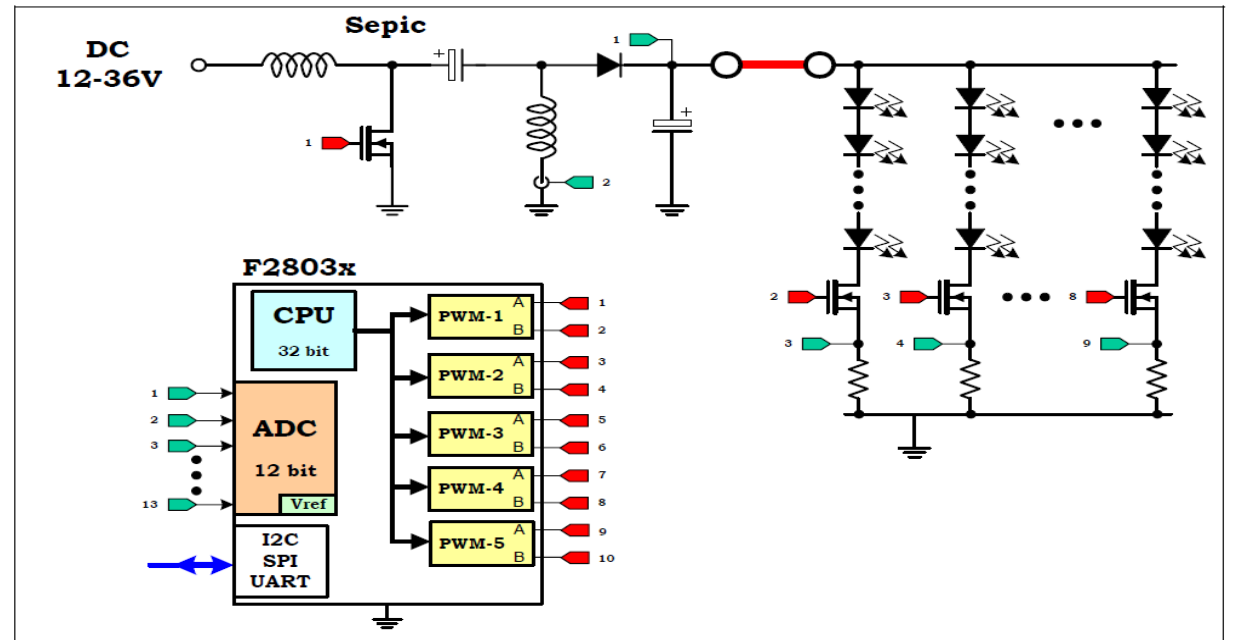

Fig4: DC/DC LED Lighting Board Block diagram with F28035

ZKW Lichtsysteme GmbH

Rapid Control Prototyping with Simulink Real-Time and Speedgoat:

- Design control algorithms for an innovative LED headlamp projection technology changing its illumination dynamically
- Seamless integration into MathWorks Tools
- Faster time to market



"Model-based design itself has proven to be very flexible, powerful and efficient for our purposes. Using the Mobile real-time target machine from Speedgoat, we were able to completely redesign a functional prototype based on a model and verify it during an afternoon session."

- Matthaues Artmann, Manager Electronics Engineering Pre- and Module Development, ZKW Lichtsysteme GmbH



[Official Speedgoat User Story](#)

<https://www.youtube.com/watch?v=wAk9e5w0dSg>

Developing DC-DC Converter Control with Simulink

- Model the converter and calculate the most efficient operating region
- Determine power losses and the thermal behaviour of the converter
- Design control algorithm based on time/frequency domain specification
- Design supervisory logic and implement unit testing
- Implement power electronic controls on an embedded platform

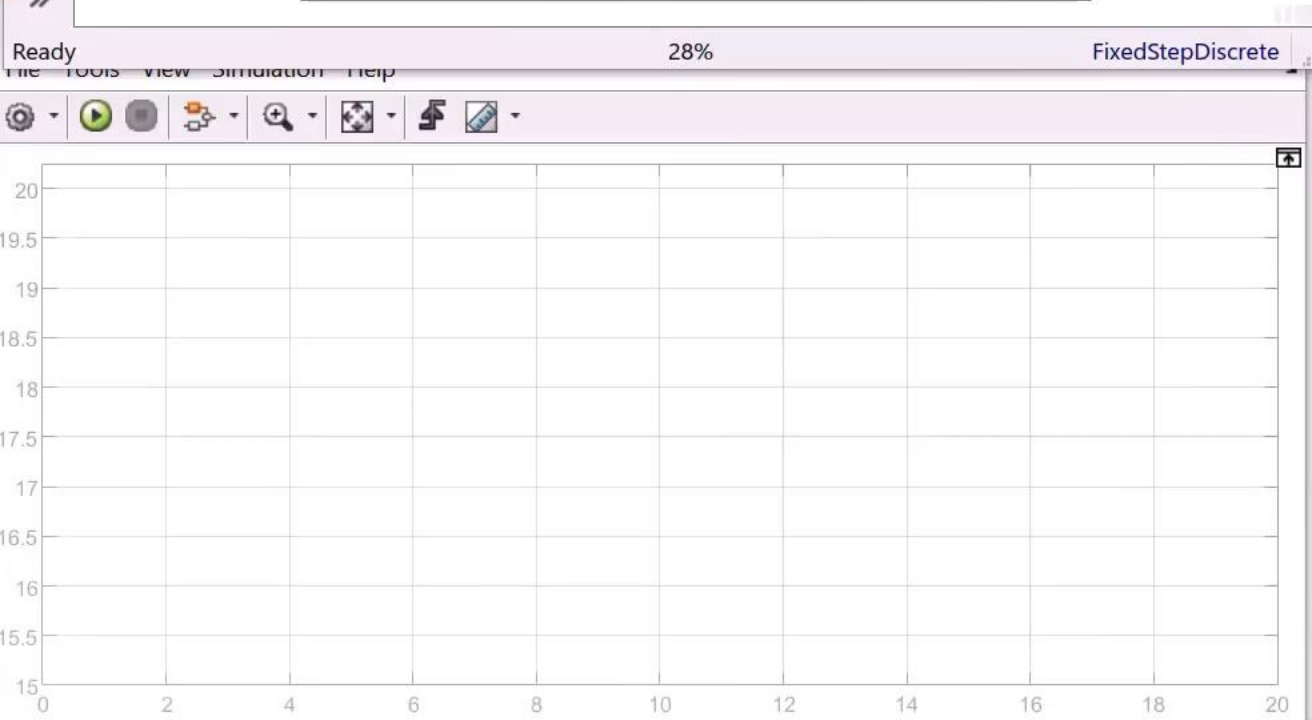
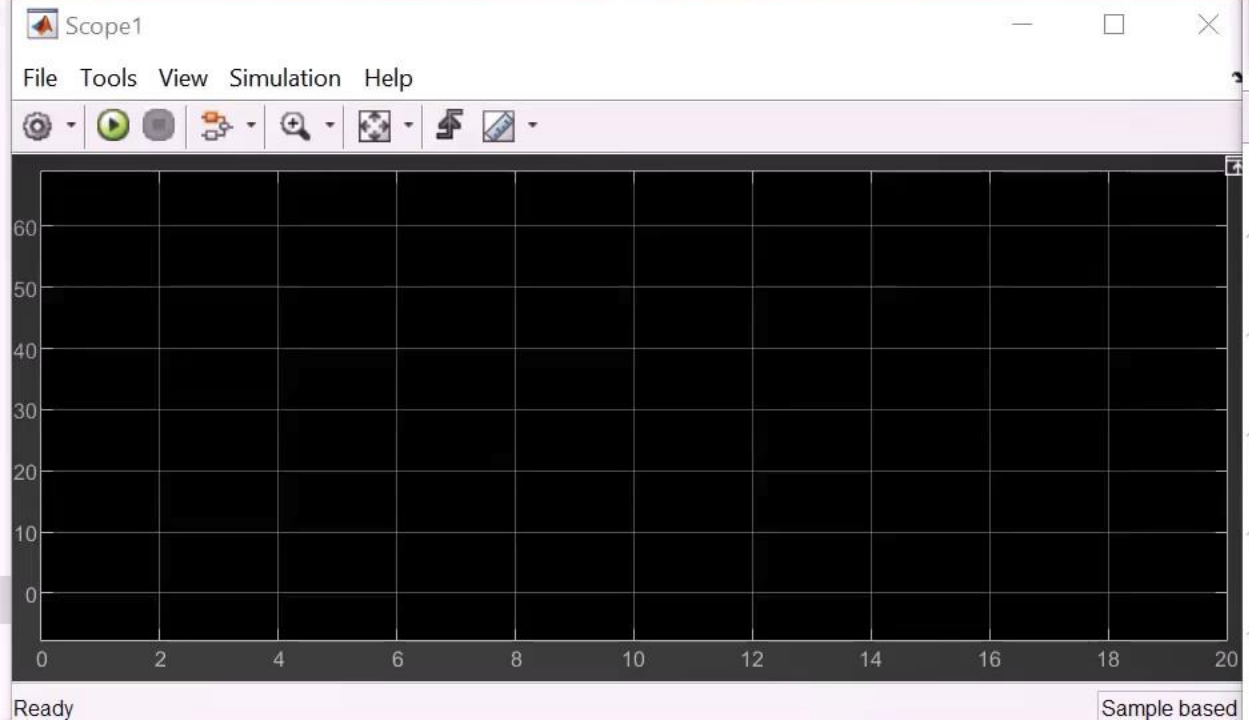
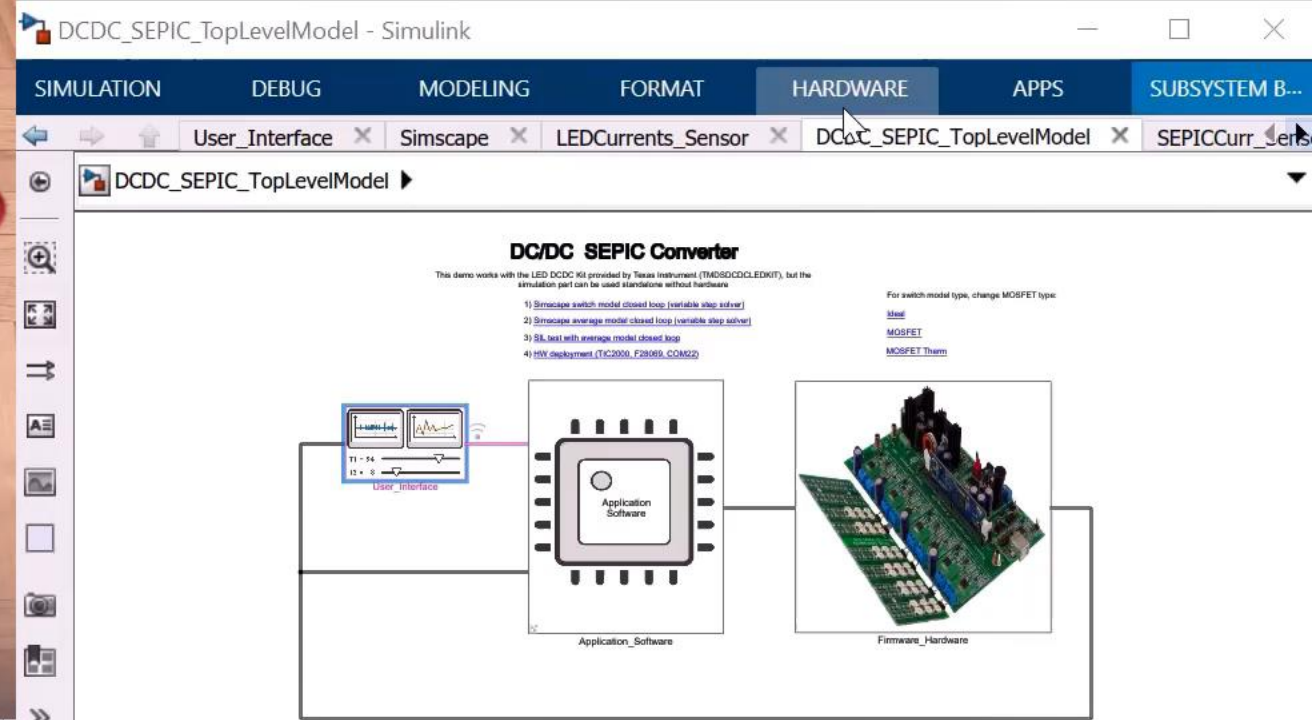

Developing DC-DC Converter Control with Simulink

- **Model the converter and calculate the most efficient operating region**
- Determine power losses and the thermal behaviour of the converter
- Design control algorithm based on time/frequency domain specification
- Design supervisory logic and implement unit testing
- Implement power electronic controls on an embedded platform

Modeling the converter

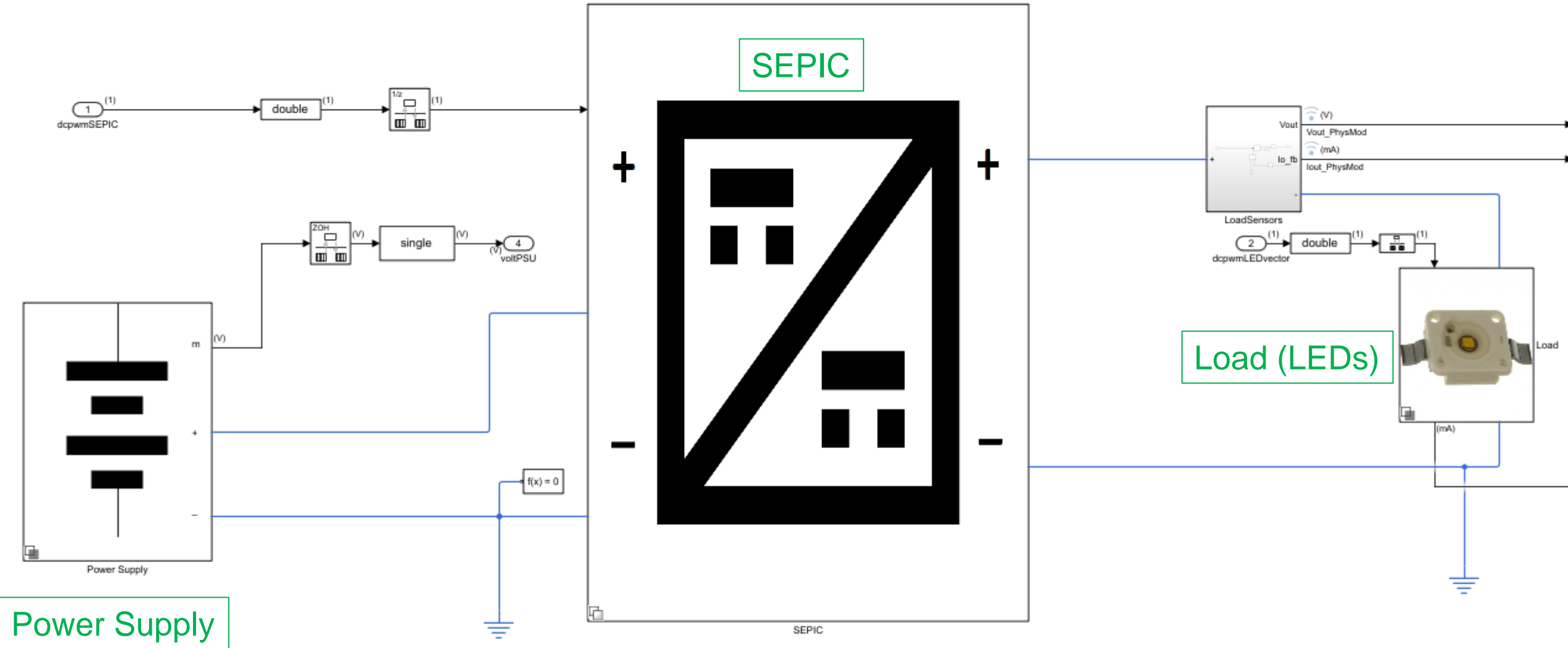

Modeling Approaches

First Principles

Data-Driven

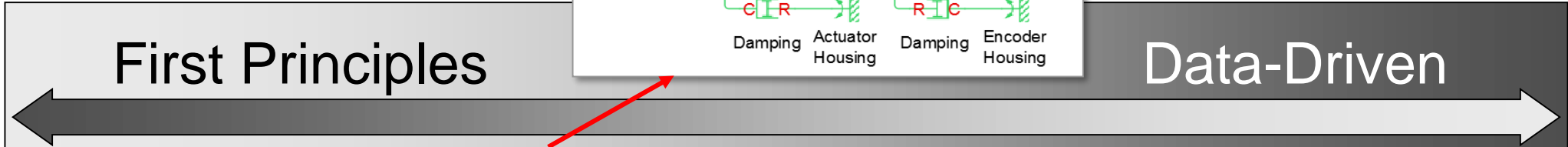
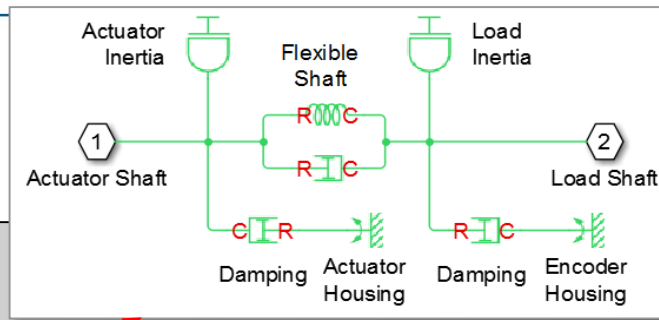

Programming Physical Networks Statistical Methods System Identification

Block Diagram Modeling Language

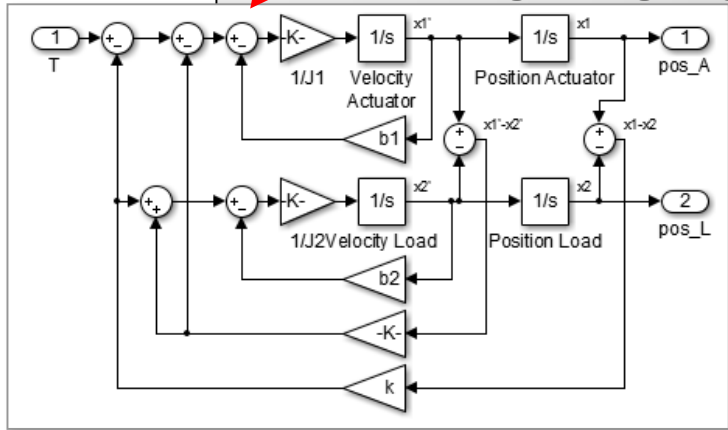

Parameter Tuning

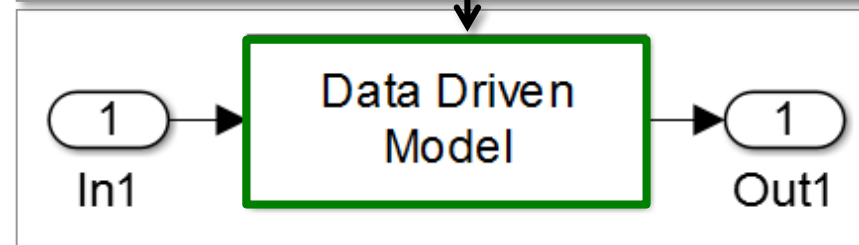
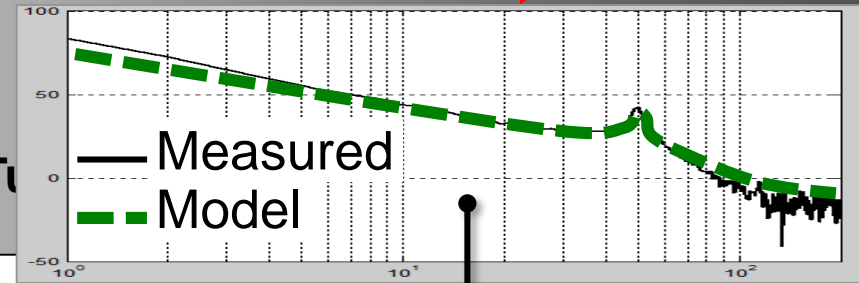

Simscape Products

- MATLAB and Simulink provide foundation for technical computing and algorithm development
- Simscape platform
 - Simulation engine and custom diagnostics
 - Foundation libraries in many domains
 - Language for defining custom blocks
- Simscape add-on libraries

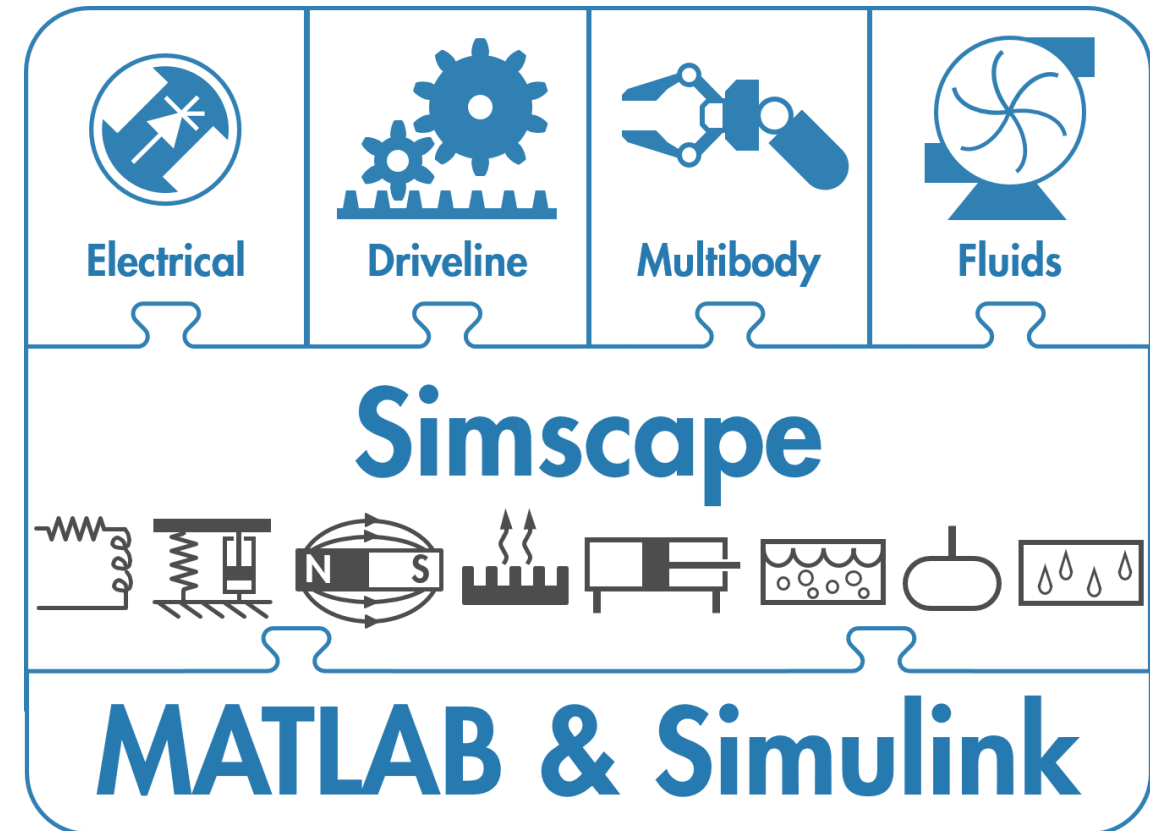

What's new in Simscape Electrical

- Parametrized Stepper motor block
- Parametrized Battery block
- Faults
 - Dynamic Load from DC or AC supply
 - Constant Power Load
 - Delta-Connected Load, Wye-Connected Load

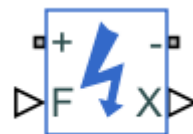

Stepper Motor

Battery
(Table-Based)

Fault

Block Parameterization Manager

Select part: A123/ALM12V7

Attribute	A123/ALM12V7
Manufacture	A123/ANR26650M1
Part number	Korea_Powercell/PD3032
Part series	Panasonic/NCA463436A
Web link	Panasonic/NCA593446
Part type	Panasonic/NCA793540
Parameteriz	Panasonic/NCR18650BD
Parameteriz	Panasonic/NCR18650BF
Part data file	Panasonic/NCR18650PF
	Panasonic/UF103450P
	Panasonic/UF553443ZU
	Panasonic/UF653450S
	Panasonic/UR18650A
	Panasonic/UR18650ZTA
	Valence/U1_12XP
	Valence/U24_24XP
	Valence/U27_12XP
	Valence/U27_24XP
	Valence/U27_36XP
	Valence/UEV_18XP

Update block with selected part

Difference block with selected part

Developing DC-DC Converter Control with Simulink

- Model the converter and calculate the most efficient operating region
- **Determine power losses and the thermal behaviour of the converter**
- Design control algorithm based on time/frequency domain specification
- Design supervisory logic and implement unit testing
- Implement power electronic controls on an embedded platform

Recap: What have we seen?

- Create heat maps
- Reuse it in extremely fast thermal-focused model for cooling sizing and control

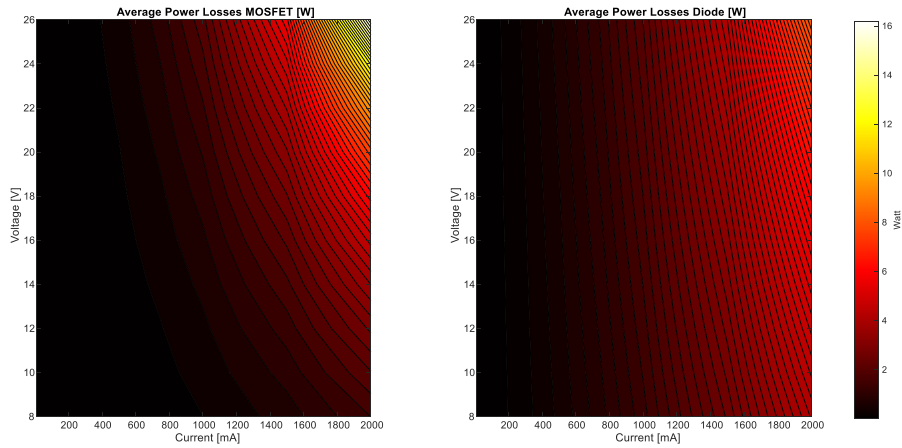

ee_switching_power_supply_thermal

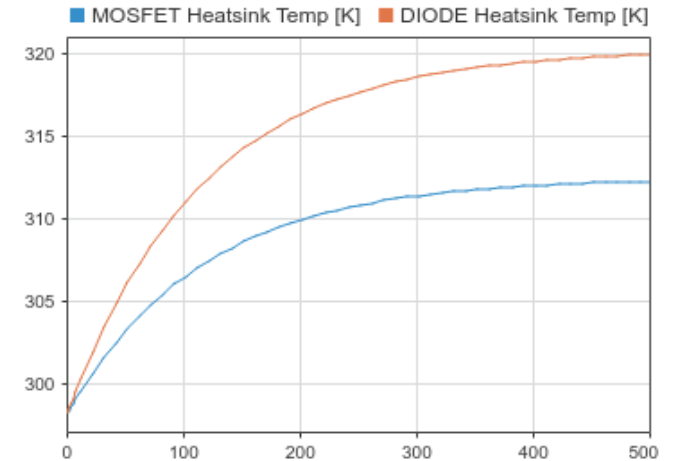
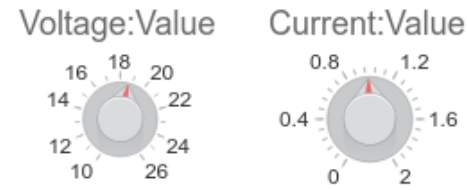
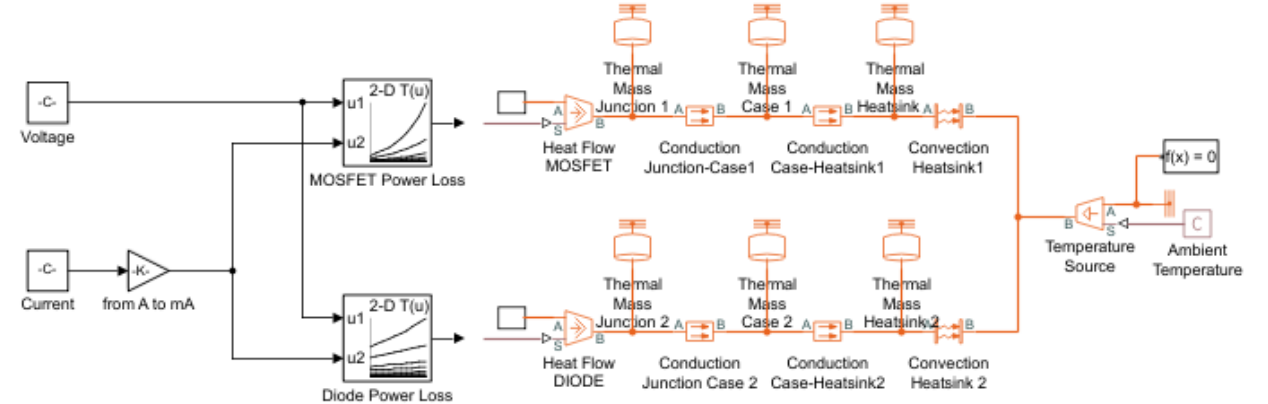

[ee_getpowerlossSummary](#)

Convert SPICE models into Simscape components

Netlist

```
testmosfetNetlist.txt x +
.FUNC Idiode(Usd,Tj,Iss) {exp(min(10
.FUNC Idiod(Usd,Tj)      {a*Idiode(0

.FUNC Pr(Vss0,Vssp)     {Vss0*Vss0/Rm+V

.FUNC J1(d,g,T,da,s,x) {a*(s*(exp(min

.FUNC QCds(x) {Cds3*min(x,x1)+Cds0*ma
.FUNC QCdg(x) {Cox4*min(x,x3)+Cox3*ma
```

subcircuit2ssc



```
testMosfetNetlist.txt x ipt015n10n5_l1.ssc x +
components (ExternalAccess=observe)
  X1 = test.s5_100_f_var(a=act,rs=r
      rs=rs,rp=rd,dc=dc,rm=rm);
  RG = elec.passive.instrumented_res
  LG = foundation.electrical.element
      i_L.priority=priority.none);
  RSA = elec.passive.instrumented_re
  LS = foundation.electrical.element
      i_L.priority=priority.none);
```

Simscape Electrical

SPICE Models

- Manufacturer-specific MOSFETs
- Additional transistor capacitance models in SPICE NMOS and SPICE PMOS blocks
 - Meyer gate or charge conservation
- Conversion Assistant supports table SPICE function
- Validate MOSFET conversions by generating characteristics and comparing with LTspice

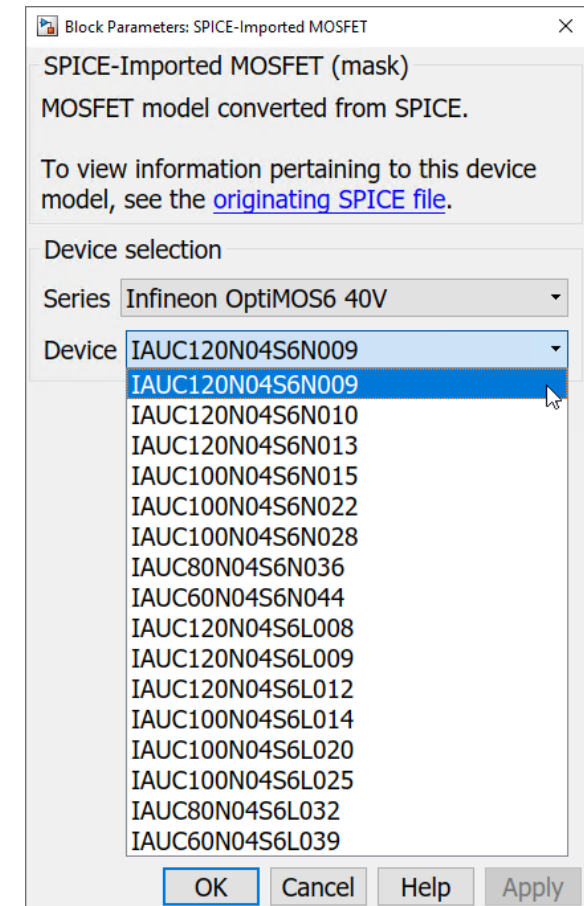
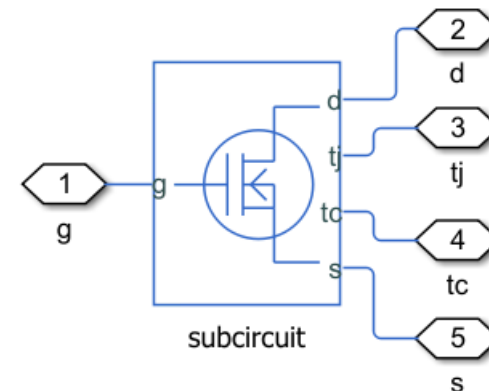
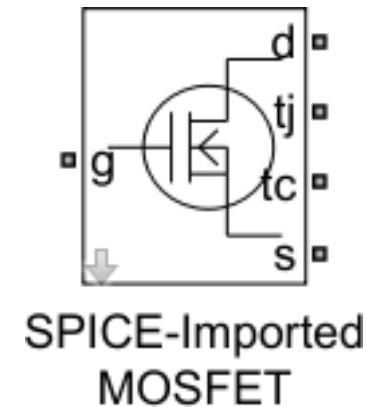

Developing DC-DC Converter Control with Simulink

- Model the converter and calculate the most efficient operating region
- Determine power losses and the thermal behaviour of the converter
- **Design control algorithm based on time/frequency domain specification**
- Design supervisory logic and implement unit testing
- Implement power electronic controls on an embedded platform

Voltage Controller Design

- Requirement
 - Implement voltage controller and tune it
- Approach
 - Create transfer function equivalent model
 - Tune controllers based on requirements

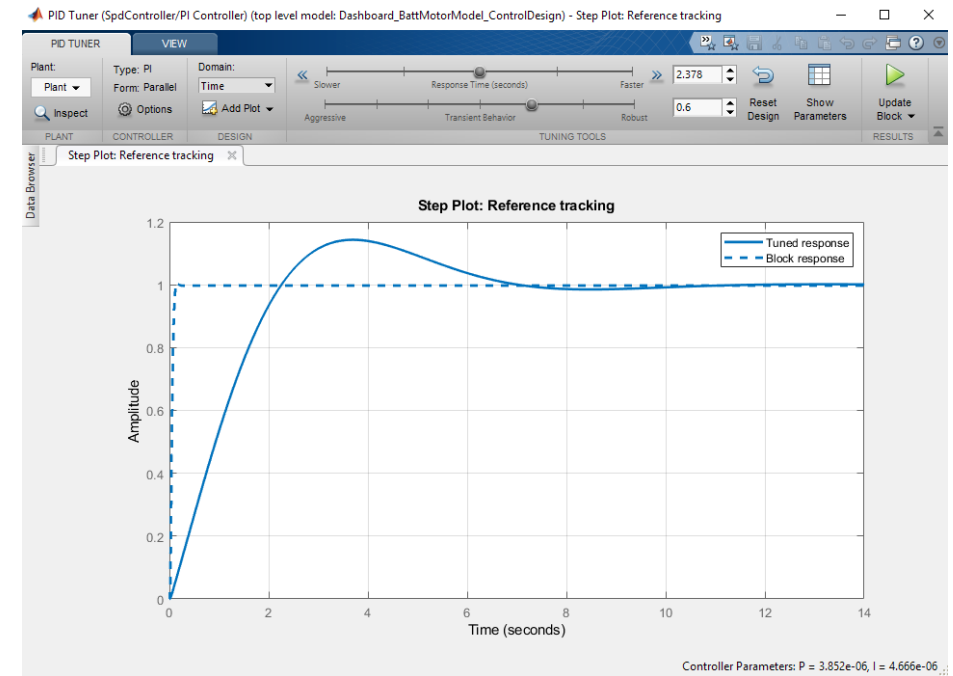

What have we seen?

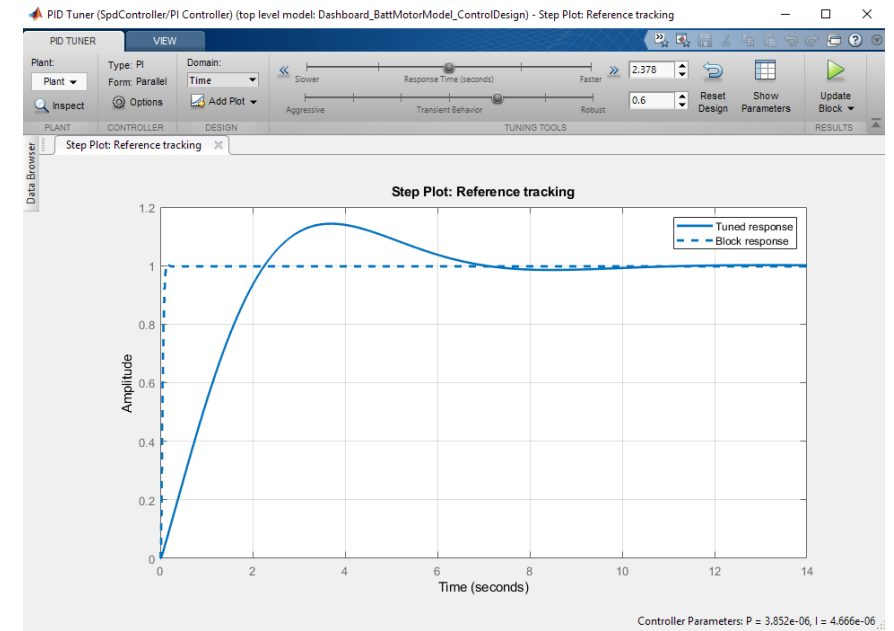
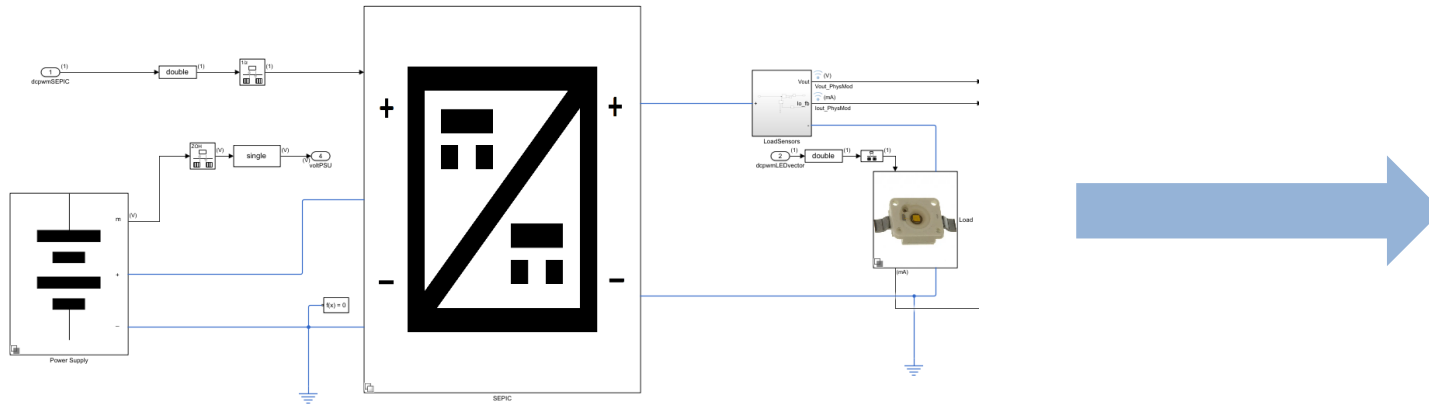

- Tuning based on System Identification
- Works with any topology

Average switch option for converters and choppers

- Faster simulation by using modulation signal or undersampling as gate signal
 - Bidirectional DC-DC Converter
 - Boost Converter
 - Buck Converter
 - Buck-Boost Converter
 - Converter (Three-Phase)
 - Four-Quadrant Chopper
 - One-Quadrant Chopper
 - Three-Level Converter (Three-Phase)
 - Two-Quadrant Chopper

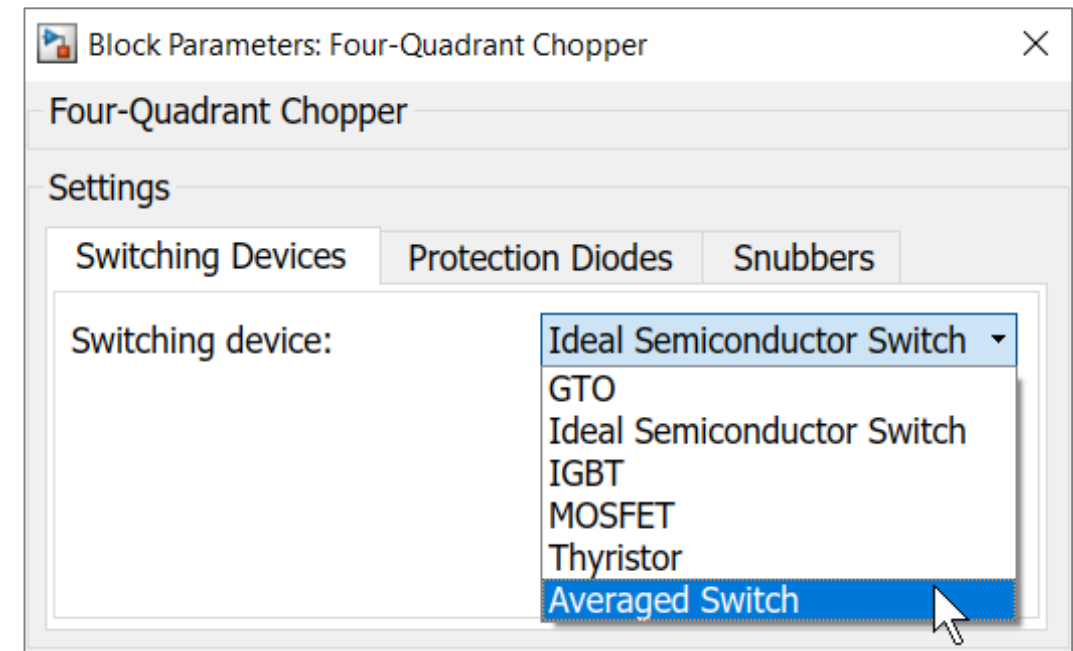
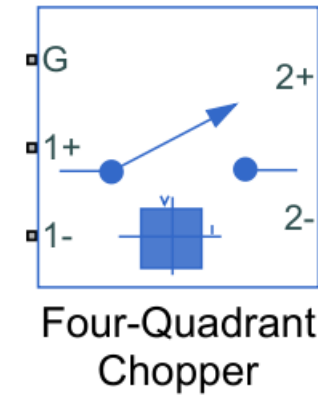

Developing DC-DC Converter Control with Simulink

- Model the converter and calculate the most efficient operating region
- Determine power losses and the thermal behaviour of the converter
- Design control algorithm based on time/frequency domain specification
- **Design supervisory logic and implement unit testing**
- Implement power electronic controls on an embedded platform

Recap: What have we seen?

Stateflow

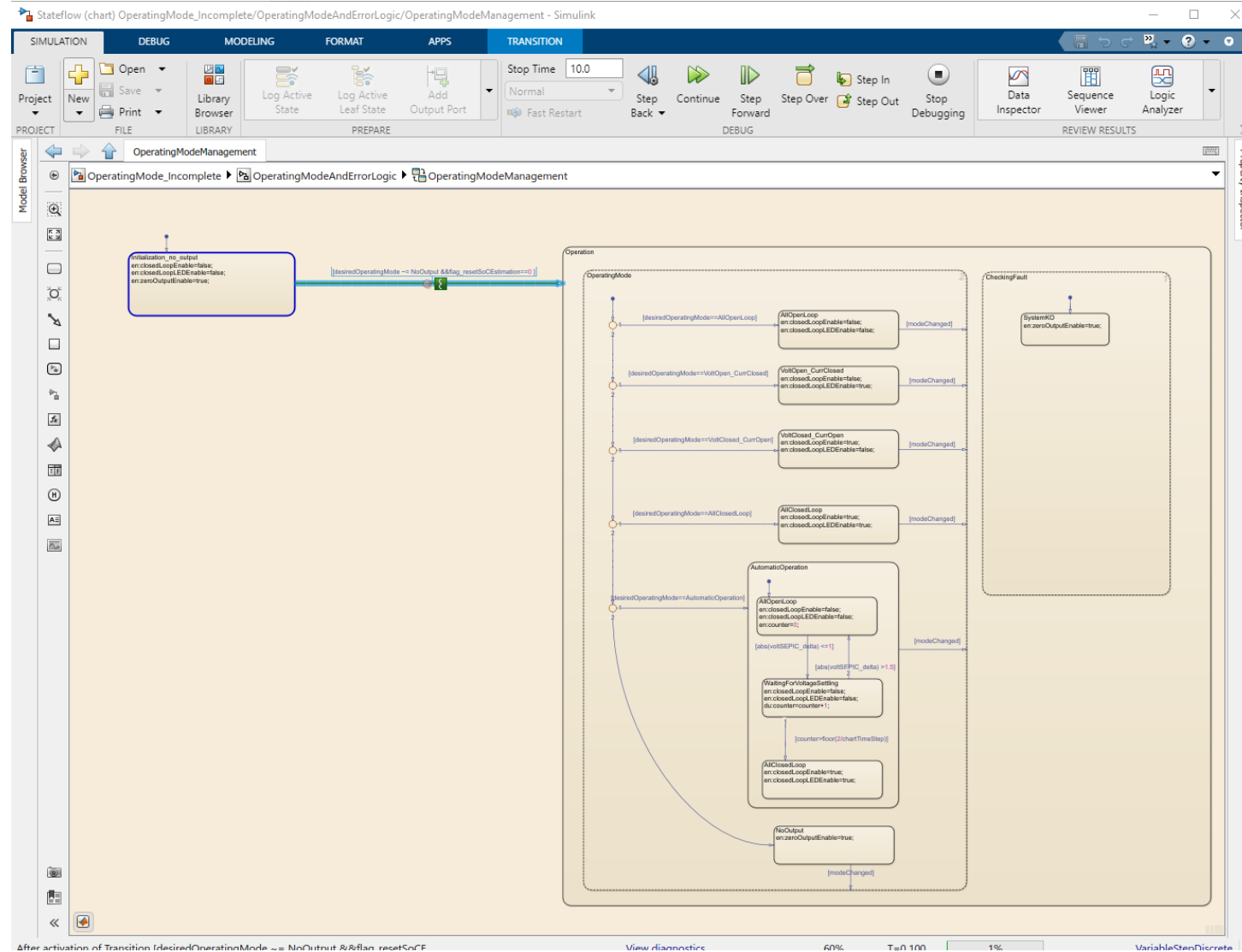

Recap: What have we seen?

Simulink Test

- ✓ Create test harnesses and test cases
- ✓ Group into suites and test files
- ✓ Execute individual or batch
- ✓ View result summary
- ✓ Analyze results
- ✓ Archive, export, report

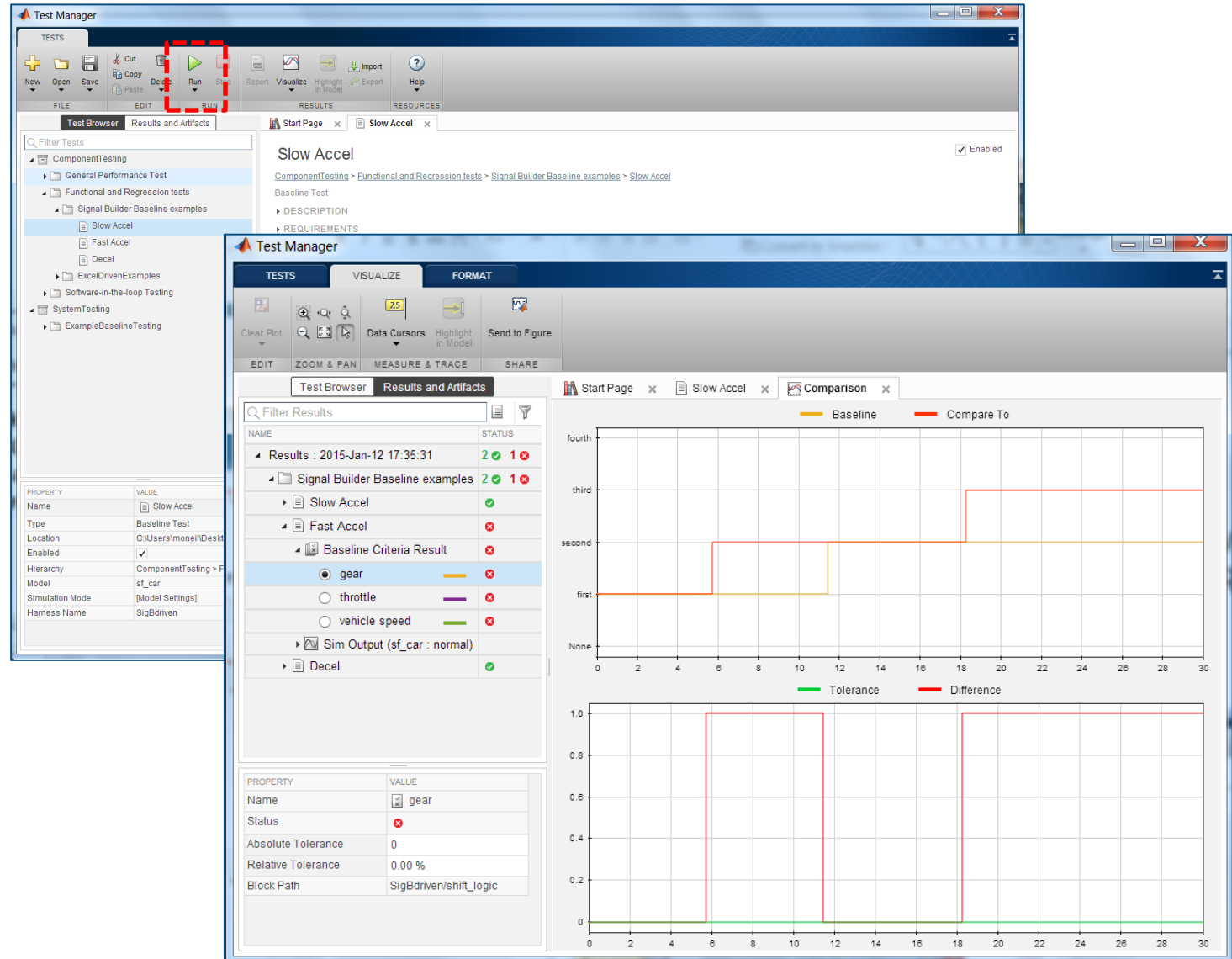

Developing DC-DC Converter Control with Simulink

- Model the converter and calculate the most efficient operating region
- Determine power losses and the thermal behaviour of the converter
- Design control algorithm based on time/frequency domain specification
- Design supervisory logic and implement unit testing
- **Implement power electronic controls on an embedded platform**

Automatic Code Generation

- Requirement
 - Generate target-aware, efficient C-code

- Approach
 - Model elaboration for C-code generation
 - Create a first configuration set with Embedded Coder Quick Start
 - Build the code, automatically generate reports

Deploy to Any Processor with Best-in-Class Performance

Models in MATLAB and Simulink can be deployed on embedded devices, edge devices, enterprise systems, the cloud, or the desktop.

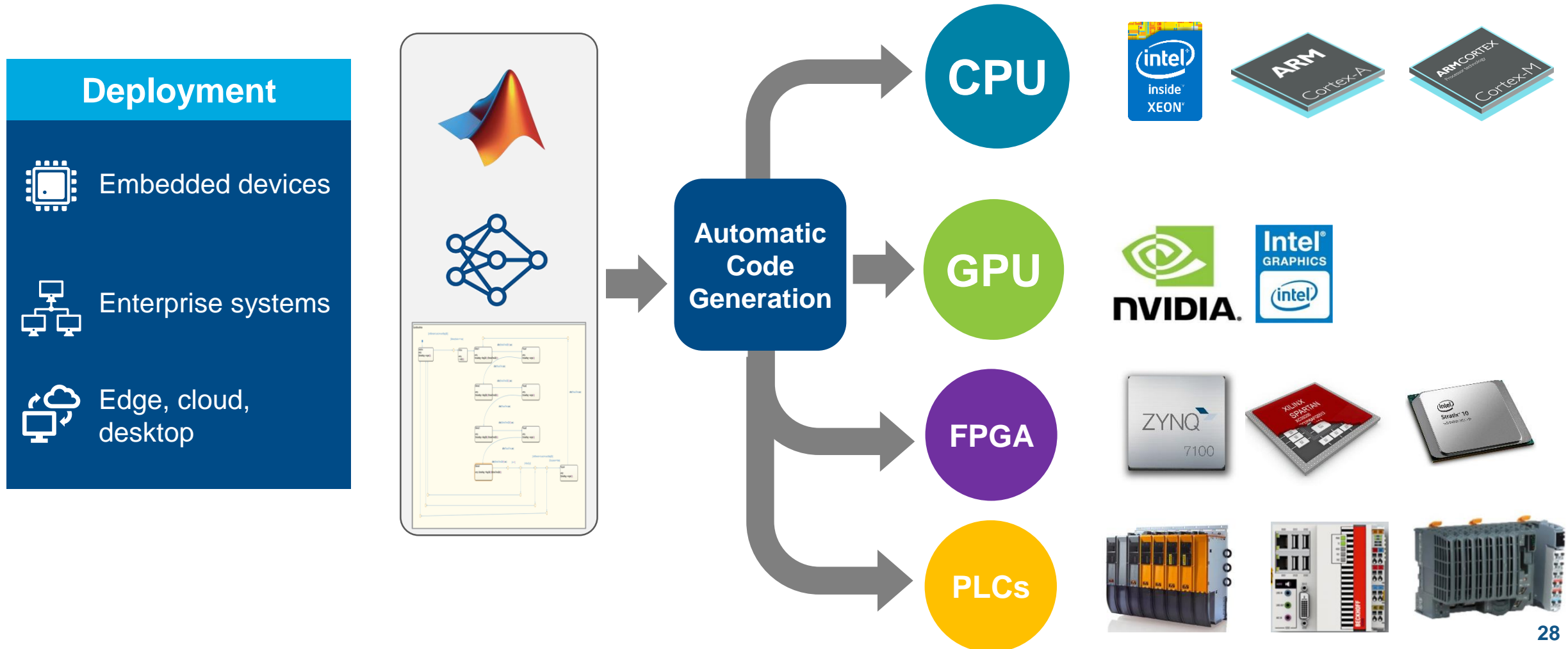

MATLAB Connects to Your Hardware Devices

Instrument Control

Oscilloscopes, Signal Generators, Lab Instruments



Data Acquisition

Plug-in data acquisition devices, I/O boards and sound cards

Image and Video Acquisition

Industrial and scientific cameras

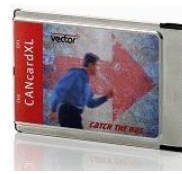

Digital Networks

OPC, CAN, J1939, and XCP protocol devices

Hardware support packages

Built-in and downloadable support for a wide range of devices and development boards



Project and File Management

Simulink Project Upgrade

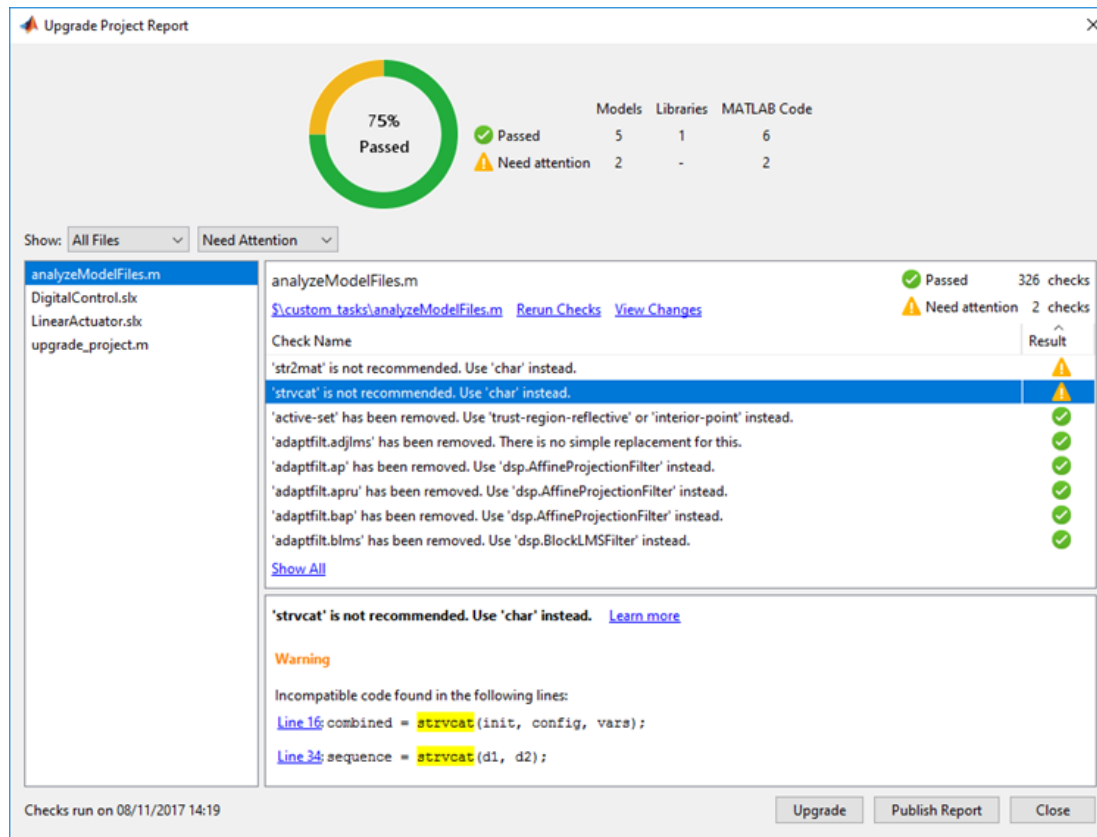

Included in Simulink since 2017b!

Simulink Graphical Model Comparison & Merge

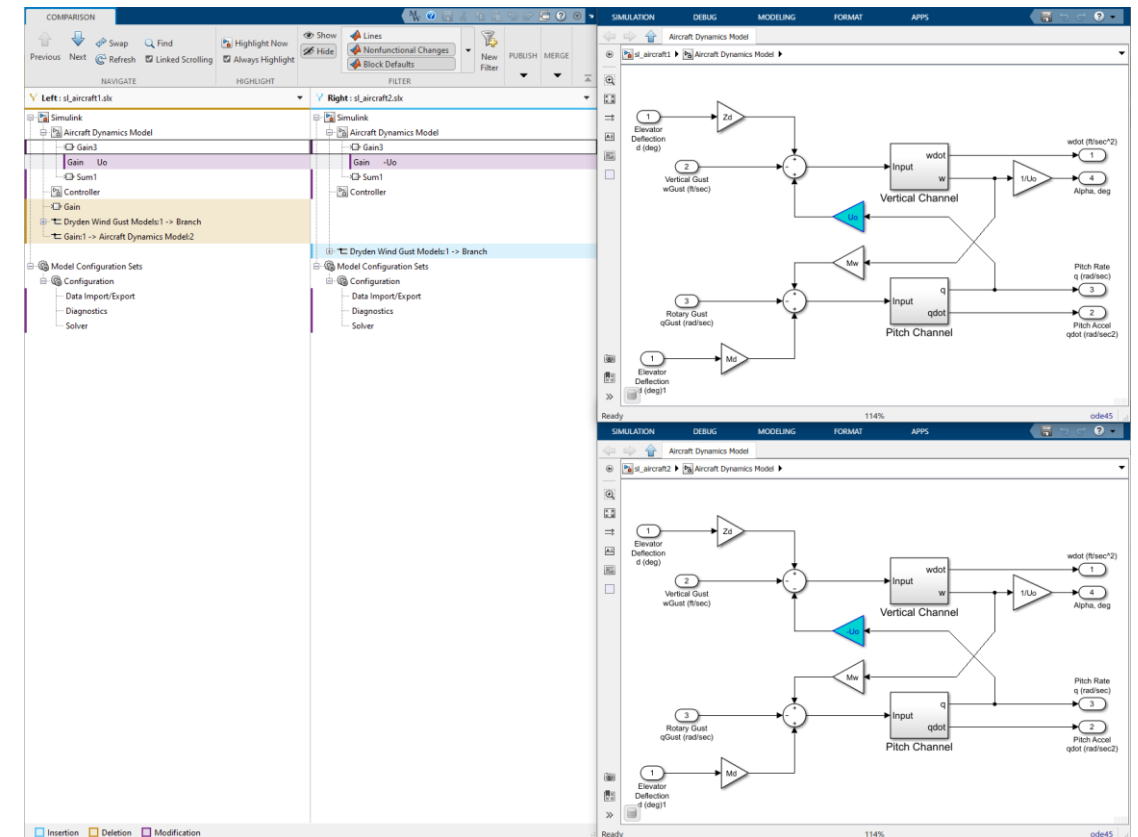

In-the-Loop Verification Methodologies

Software-in-the-Loop

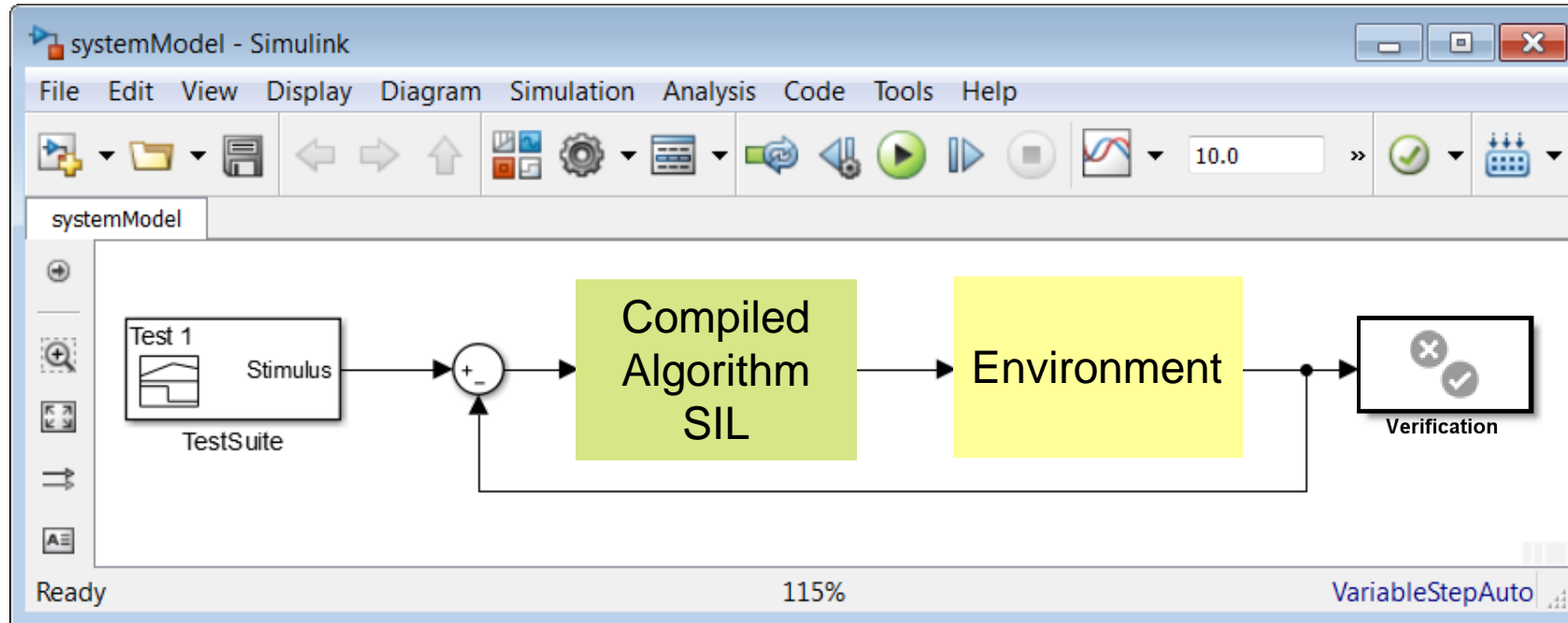

Is the generated code functionally equivalent to the model ?

In-the-Loop Verification Methodologies

Processor or FPGA-in-the-Loop

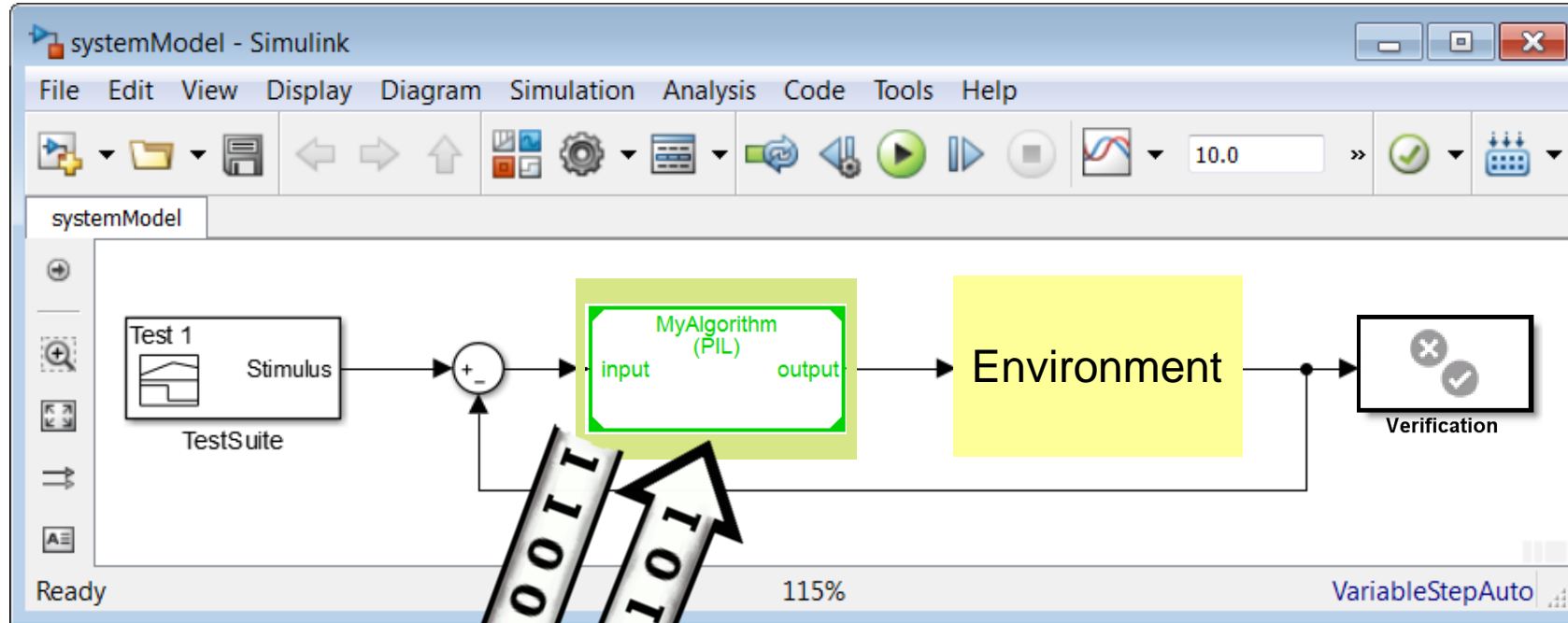

Is the generated code functionally equivalent to the model ?

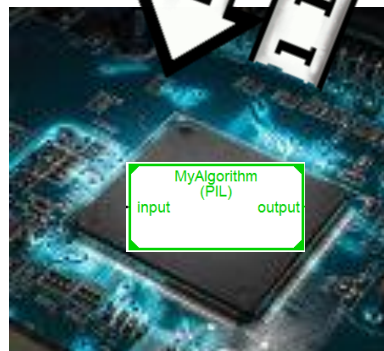

Non-Real-Time functional verification of the algorithm component, C or HDL

In-the-loop verification methodologies

Hardware-in-the-Loop: "HIL"

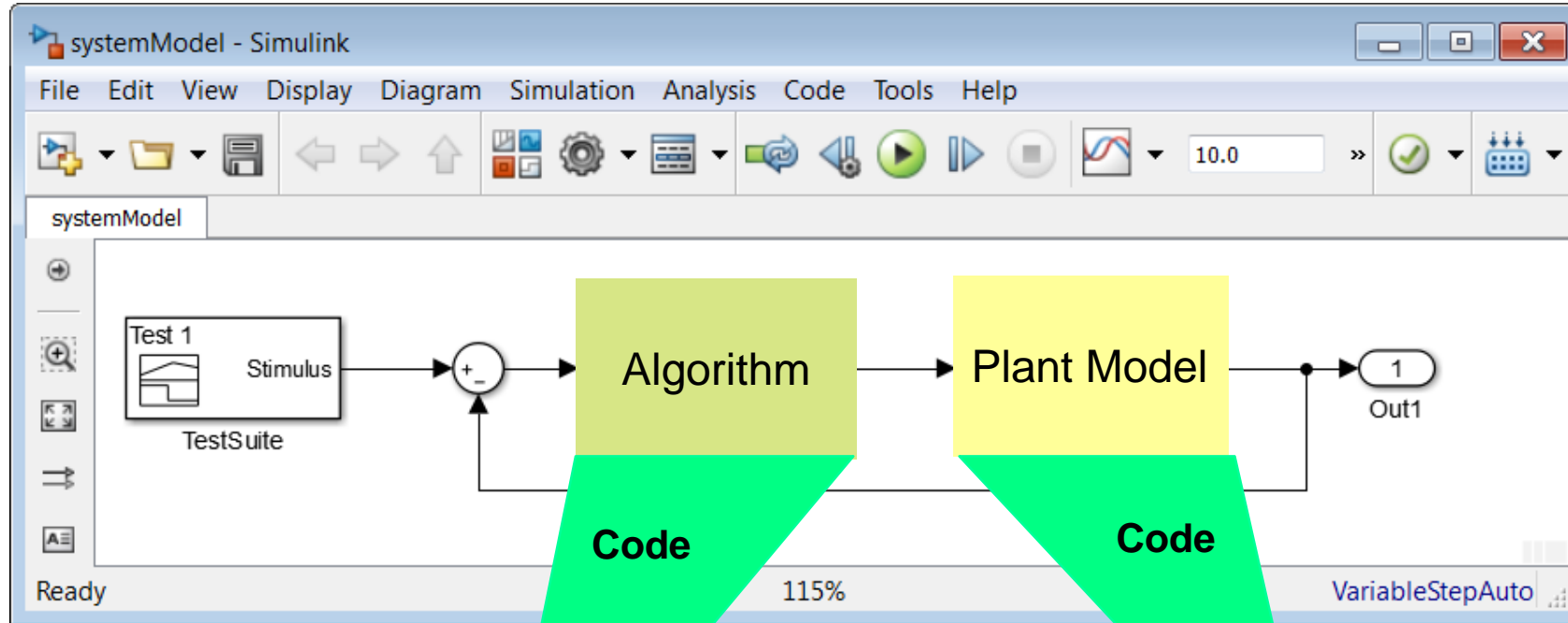

Does algorithm perform well on actual device with true latencies?

Production embedded target:
Structured Text, VHDL, C/C++



Real-Time Machine
eg "Speedgoat"

About Speedgoat

- A MathWorks associate company, incorporated in 2006 by former MathWorks employees. Headquarters in Switzerland, with subsidiaries in the USA and Germany
- Provider of real-time target computers, expressly designed for use with Simulink
- Real-time core team of around 200 people within MathWorks and Speedgoat. Closely working with the entire MathWorks organization employing around 5,000 people worldwide



Hardware-in-the-Loop Simulation of SEPIC Converter

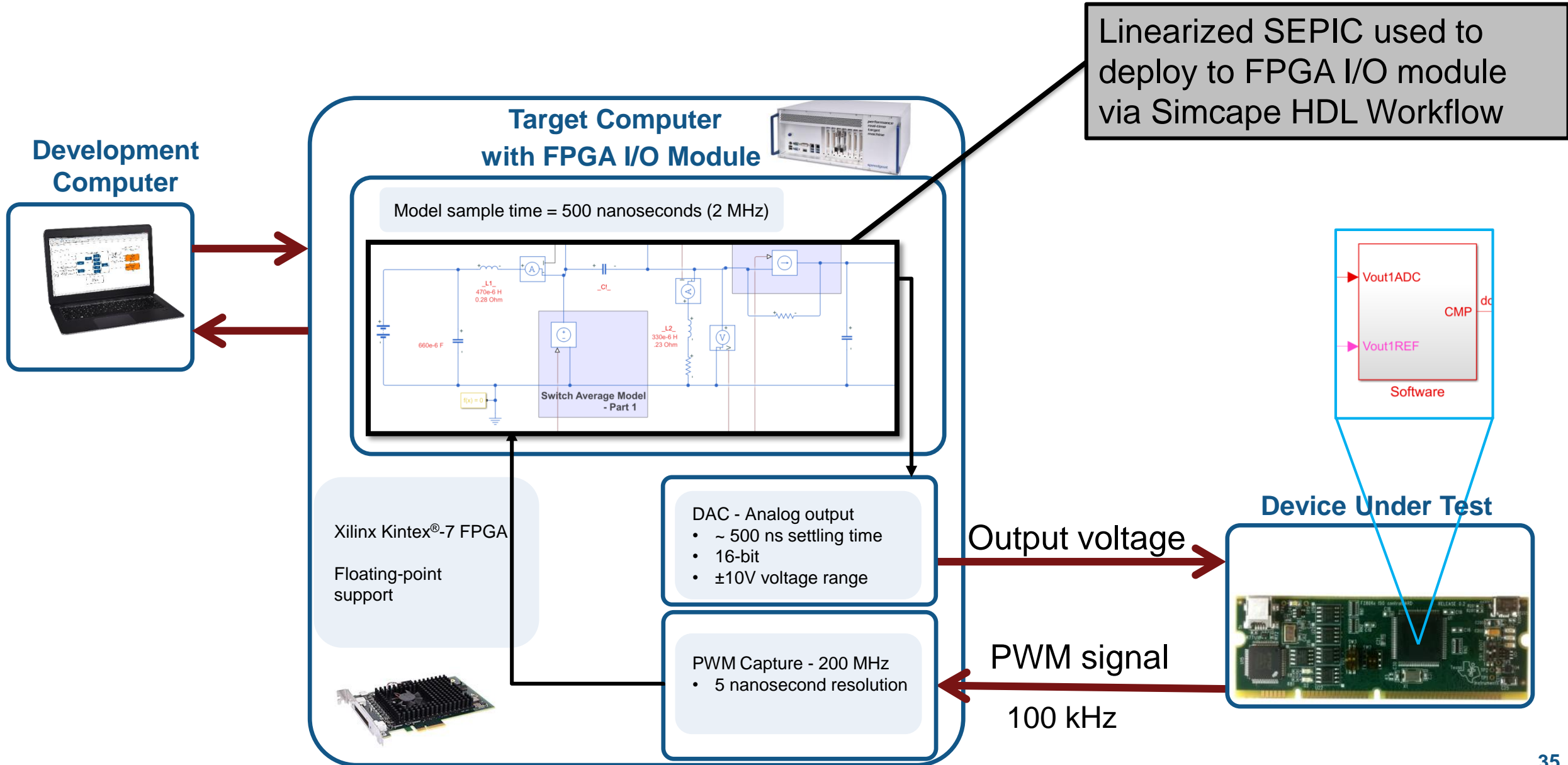

Hardware-in-the-loop simulation of SEPIC converter

SEPIC Controller is Deployed to C2000 microcontroller

Hardware Board: Closed_Loop_Control_Voltage_HIL, Closed_Loop_Control

Target: TargetPC3, Connected

Block Diagram: gm_SEPIC_TI_Averaging_hdlgm_slrt

➔

Deploy

PicoScope 6

Measurements:

Channel	Name	Value	Min	Max	Average	σ
A	Frequency	253.6 kHz	240.5 kHz	370.2 kHz	307.3 kHz	39.81 kHz
A	Duty Cycle	10 %	2.857 %	100 %	34.54 %	38.45 %
B	DC Average	22.22 mV	20.56 mV	24.7 mV	22.29 mV	1.177 mV
C	DC Average	1.007 V	1.007 V	1.007 V	1.007 V	2.347 μ V

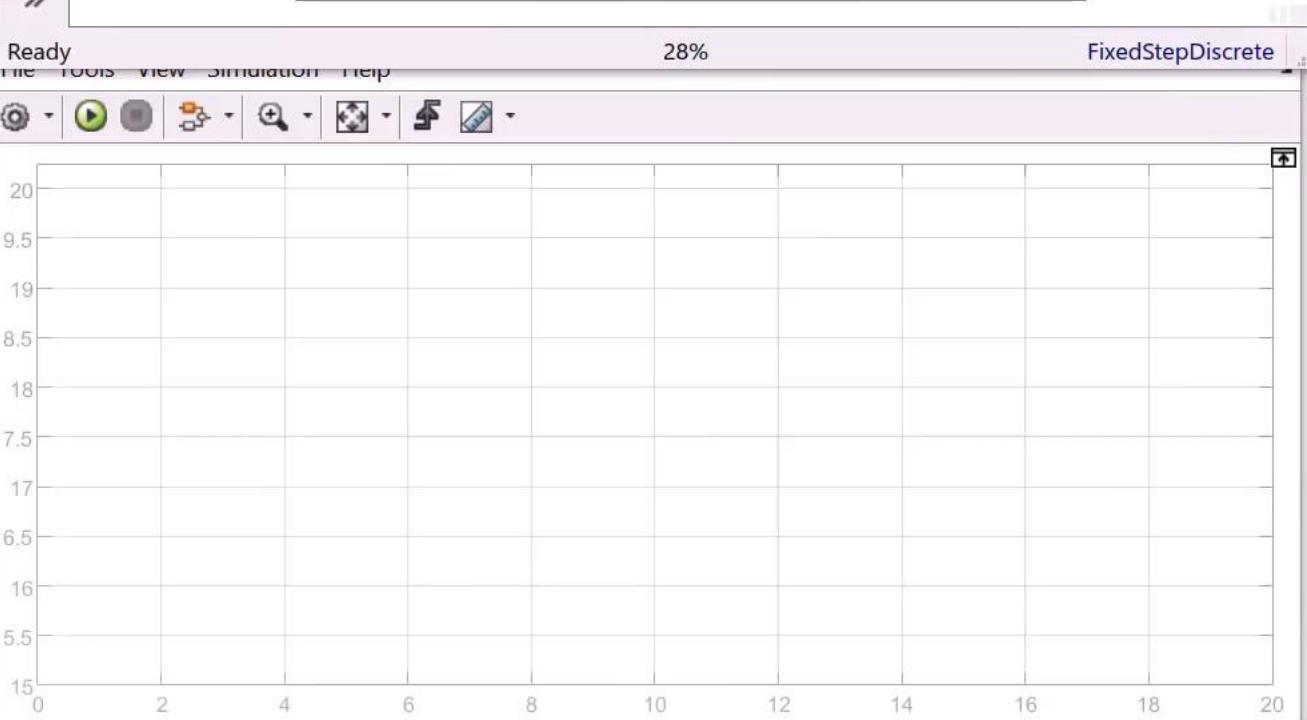
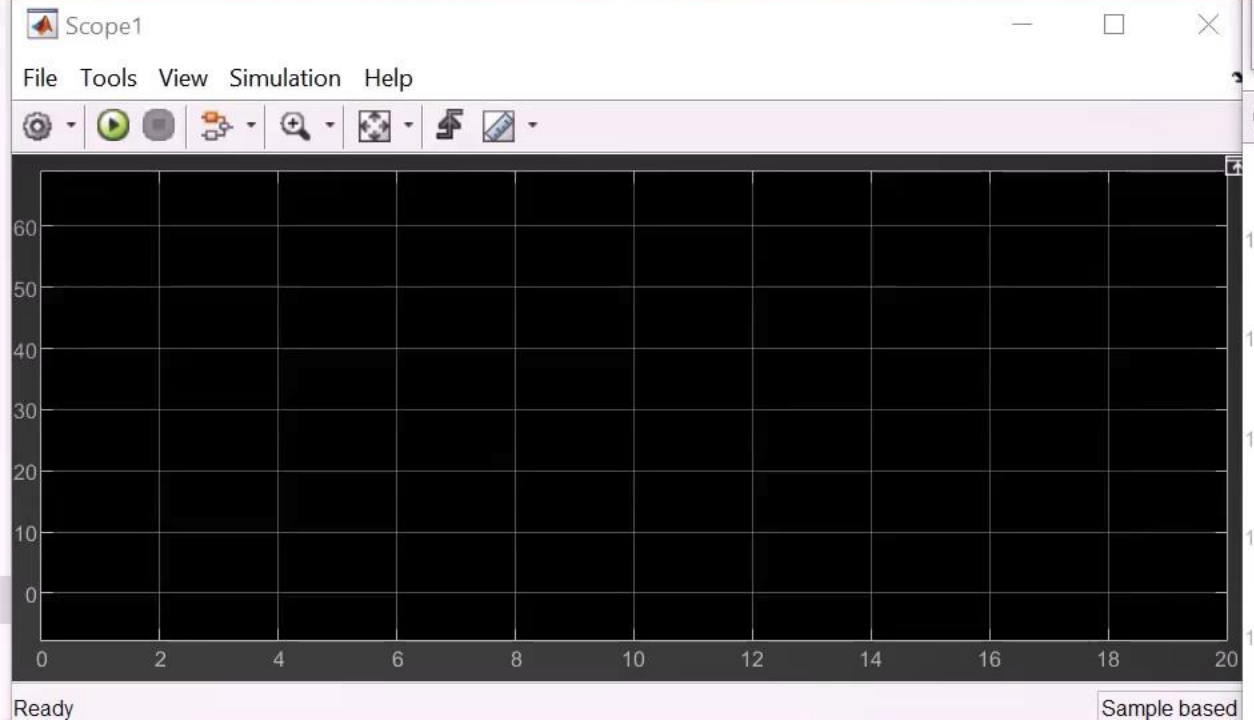
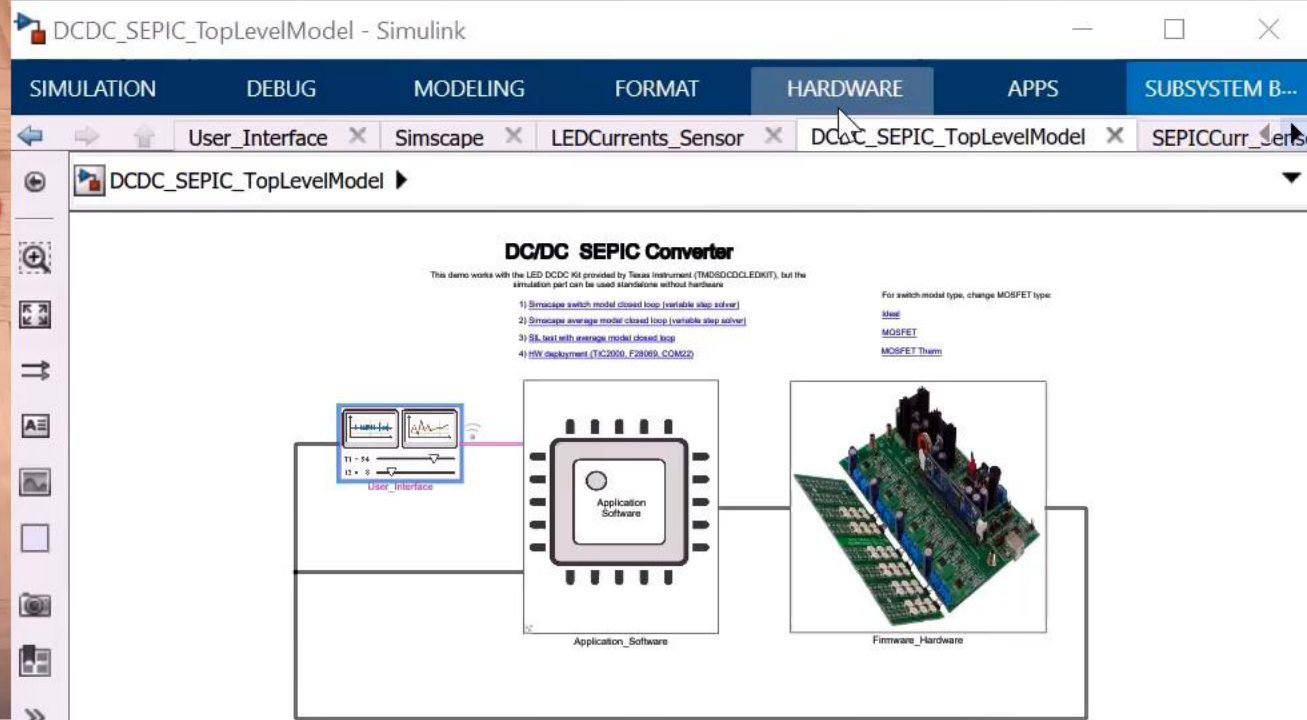

With Simulink and Model-Based Design

Use Simulation Models to Generate Production Ready Code



A cabinet of Power Electronic Building Blocks (PEBBs).

*“With Model-Based Design, our developer productivity is easily increased tenfold. **Simulation and code generation enable us to turn changes around quickly and eliminate human errors in coding.** Our algorithms typically work the first time, so we no longer waste a big part of our development cycle debugging code.”*

Dr. Robert Turner, ABB [link](#)

Key Takeaways

- Graphical programming across our solutions is **intuitive** and **powerful**
- State-of-the-art technologies facilitate the **design** and **verification** of complex systems developed by **multidisciplinary teams**
- Find design errors **early** and cut down development **cost** while increasing delivered **quality**.

Visit the Power Electronics Control Community on MATLAB Central to find Models, Answers, and How-to Videos



Power Electronics Control Community

<https://www.mathworks.com/matlabcentral/topics/power-electronics-control.html>

Visit
MATLAB
Central

more
Get answers to your MATLAB and Simulink questions

277,020
Questions answered

149,237
Answers accepted

328,024
Members contributing

Visit
MATLAB
Central

Q&A and Conclusion

- Questions: vlenzi@mathworks.com